

# **AMANO®**

## **PIX MODELS: 10, 15, 20, 21**

### **Electronic Time Recorder**

#### **User's Guide**



BC TIME RECORDERS  
800-565-3575  
604-856-8433  
Email: [bctime@shaw.ca](mailto:bctime@shaw.ca)

2. Insert the key provided and turn clockwise to open the case. Lift the cover to remove.

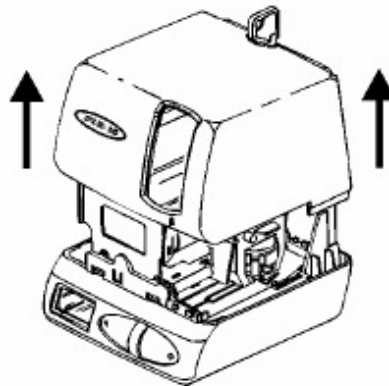

3. Remove the spacer between the Ribbon Cartridge and the Printer Carriage.

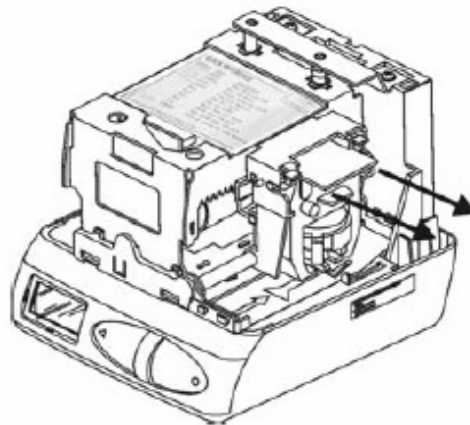

4. Re-install the cover. Your PIX-15 is ready for use!

## Before You Change Any Settings

Take a moment to familiarize yourself with the items explained below.

### The Front Panel

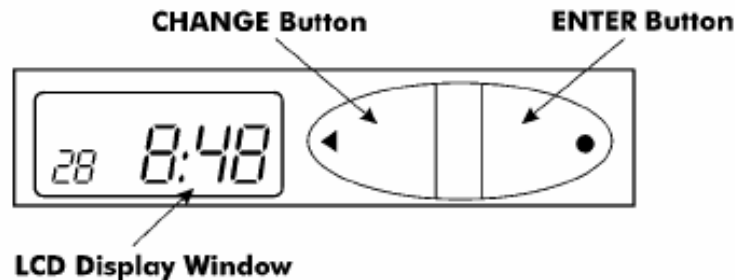

Normally, the **Display Window** shows the date and time. When you use the Quick Set or Program Mode to change the settings of the PIX-15, the instructions to change the clock are shown in this window.

The two buttons on the front panel are used to navigate through the Quick Set and Program Mode to change the clock's settings.

The left button is marked with a ◀ symbol. It is called the **CHANGE Button**. Use this button to change the information shown on the display when you are in the Quick Set or Program Mode.

The right button is marked with a ● symbol. It is called the **ENTER Button**. When you are in the Quick Set or Program Mode, use this button to enter the setting shown on the display into memory.

### The Reset Button

The **RESET Button** (which is shaped like a post) is located on the bottom of the clock.

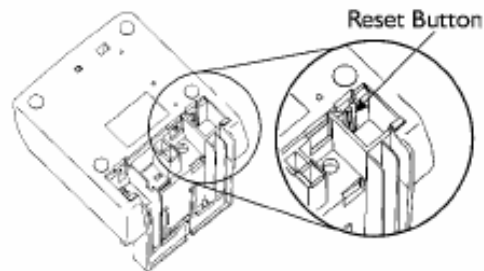

#### Please Note:

You do not need the key to set the time or to program the clock!!

---

## Make a Test Print

1. Plug in the power cord.
2. Insert a piece of paper or time card into the PIX-15. The clock will automatically print YEAR, MONTH, DATE and TIME with AM or PM (in Pacific Time).

'98 MAR 9 PM 4:05

**Note:** The PIX-15 will automatically adjust for Daylight Saving Time.

3. If the imprint is satisfactory, and you are going to place the PIX-15 on a desk, table, or shelf, the PIX-15 is ready to be used.
4. In order for you to set the time or change the print style, you must enter a code. Choose a code from the list below that best fits your needs. Continue to the next page for instructions on how to enter your code.

<u>Code</u>	<u>Print Style</u>	<u>Print Direction</u>
6510	DAY, 12H, 60th	Right Side Printing
6210	DAY, 24H, 10th	Right Side Printing
6810	DAY, 24H, 100th	Right Side Printing
6520	DATE, 12H, 60th	Right Side Printing
6620	DATE, 24H, 60th	Right Side Printing
6820	DATE, 24H, 100th	Right Side Printing
6530	MONTH, DATE, 12H, 60th	Right Side Printing
6630	MONTH, DATE, 24H, 60th	Right Side Printing
6830	MONTH, DATE, 24H, 100th	Right Side Printing
6570	YEAR, MONTH, DATE, 12H, 60th	Right Side Printing
6071	YEAR, MONTH, DATE, RCV'D	Right Side Printing
6072	YEAR, MONTH, DATE, SENT	Right Side Printing
6073	YEAR, MONTH, DATE, FAX'D	Right Side Printing
6074	YEAR, MONTH, DATE, VOID	Right Side Printing
6075	YEAR, MONTH, DATE, PAID	Right Side Printing
6076	YEAR, MONTH, DATE, CFM'D	Right Side Printing
6077	YEAR, MONTH, DATE, APR'D	Right Side Printing
6078	YEAR, MONTH, DATE, CMPL'D	Right Side Printing
6079	YEAR, MONTH, DATE, ORIGN	Right Side Printing
6070	YEAR, MONTH, DATE, FILE	Right Side Printing

## Entering the Clock Program

The following steps describe how to get into the clock program. To set the print style and time, use a code chosen from the list.

### 1. To Enter the Code

- a. Press and hold the **RESET** button on the bottom of the clock. (Refer to Page 3 for location.)
- b. While holding down the **RESET** button, press and hold the ● right button on the front panel.
- c. While holding the ● right button, release the **RESET** button.

- d. When **Prog** flashes in the display, release the ● right button.

- e. Tap the ● right button again. The display will show **0000**.

- f. Tap the ◀ left button until the first number of your code appears, then tap the ● right button.

- g. Tap the ◀ left button until the second number of your code appears, then tap the ● right button.

- h. Tap the ◀ left button until the third number of your code appears, then tap the ● right button.

- i. Tap the ◀ left button until the fourth number of your code appears, then tap the ● right button.

- j. When the display flashes all four digits, tap the ● right button again.

- k. When the display flashes **PI dALE**, tap the ◀ left button.

## 2. Set the Time

When setting the time you must use 24 hour format (i.e. 13:00 = 1:00 pm). This will **NOT** make the clock print military time, it simply tells the clock am from pm.

- a. When the display flashes P2 CLoc, tap the ● right button.
- b. The small “12” will flash. Tap the ● right button again.
- c. The hour digits will flash. Tap the ◀ left button until the correct hour appears. Remember to use a 24 hour format (2:00 pm = 14:00). Then tap the ● right button.
- d. The minutes digits will flash. Tap the ◀ left button until the correct minutes appear, then tap the ● right button twice.
- e. When the display flashes P2 CLoc, tap the ◀ left button until you see End, then tap the ● right button.

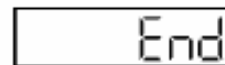
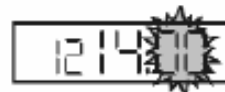

## 3. The PIX-15 is ready for use!

## Replacing the Ribbon

1. Insert the key into the key hole (see page 2 for keyhole location) and turn the key.
2. Grab the cover on both sides and lift to remove it.
3. Pull the two catches (B) upward and hold them with your index and middle fingers. Remove the ribbon cassette.

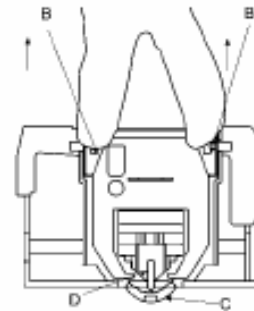

**Note:** If the print mechanism is in the down position and a piece of paper cannot be inserted, press the **RESET** button to move the carriage up. This will make the ribbon installation easier.

4. Insert a new ribbon between the ribbon guide (C) and the printer head (D).
5. Turn the knob on the cassette clockwise one turn to take up any slack in the ribbon.
6. To replace the cover, remove the key, align the lower back corners to the base of the clock and snap the cover down into position.

## Mounting the Clock

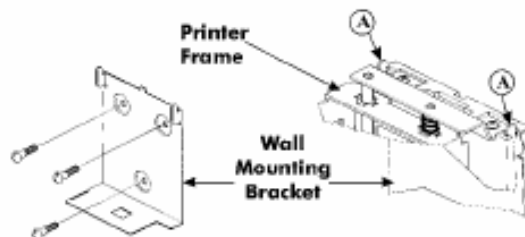

1. Remove the cover as per the instructions above.
2. With the clock facing you, remove the mounting bracket by pulling the top tabs (A) towards you, and then pushing the tabs down (see below).



3. Securely mount the PIX mounting bracket on the wall using three #10 wood screws or equivalent.
4. Place the PIX-15 on the Mounting Bracket by sliding the top tabs into the slots on each side of the case. Push the PIX-15 back and down against the Mounting Bracket until the PIX-15 snaps into place. Be careful not to pinch the power cord with the bracket. Installing the cover will secure the PIX-15 to the mounting bracket.

## Error Messages

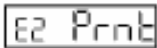
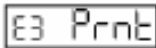
Possible Error Messages:

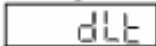
<b>Home sensor, Motor Carriage Stuck</b> 	<b>Timing sensor, Motor Carriage Stuck</b> 	<b>Home Sensor</b> 
<b>Carriage Stuck</b> 	<b>General Print Error</b> 	<b>Daylight Saving Time Program</b> 

If any of these messages appear on the display, unplug the clock from your outlet then plug it back in again. If the message still appears on your display, please contact us at 1-800-253-9836 for assistance.

## CAUTION:

Do not use any chemical solvents or oils to clean or lubricate your PIX-15. This will damage your clock. To clean the inside of your clock, blow it out with air.

## Specifications

Power Requirements: For PIX-15 Input: AC16.5V, 60Hz, 0.6A (Max.)

For AC Adapter: AC120V  $\pm$  10%, 60Hz  
 AC230V  $\pm$  10%, 50Hz  
 AC240V  $\pm$  10%, 50Hz

Ambient Temperature: -10°C to 45°C (14°F to 113°F)

Ambient Humidity: 10% to 90% (no condensation)

Dimensions: 140mm (W) x 150mm (H) x 165mm (D)  
 (5½" x 6" x 6½")

Weight: 1.8Kg (4.2 lbs.)

Environment: Indoor use only; dust-free environment  
 Keep out of direct sunlight

For PIX-15 with 120V AC Adapter:  
 Listed and Certified by Underwriters Laboratories, Inc.



BC TIME RECORDERS  
 800-565-3575  
 604-856-8433  
 Email: bctime@shaw.ca